

**SENTINEL®**

# Vortex250

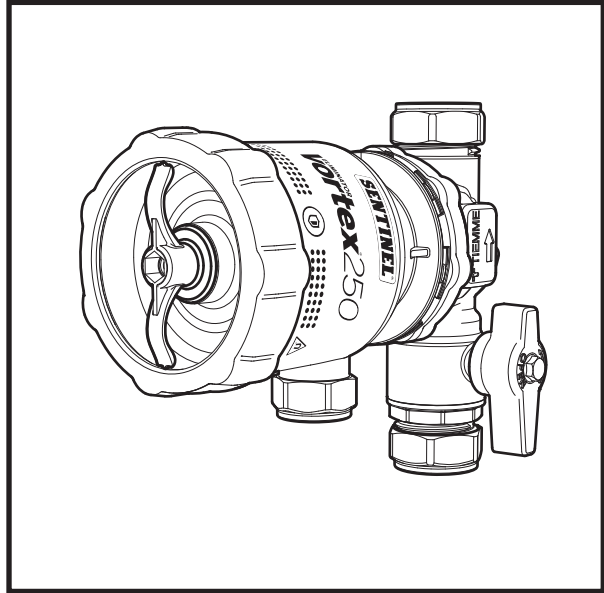

11/2020



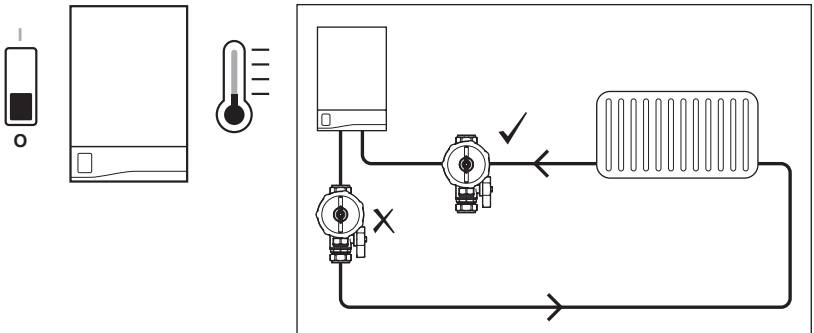
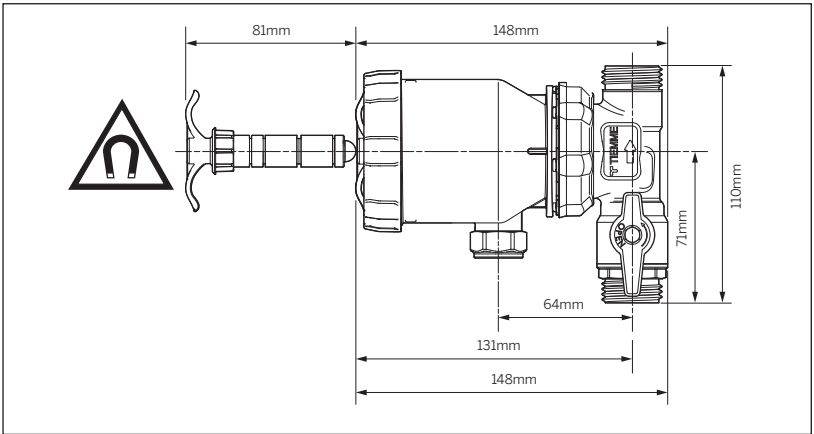

22mm

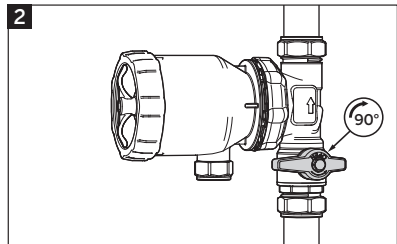
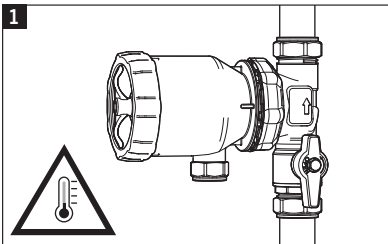
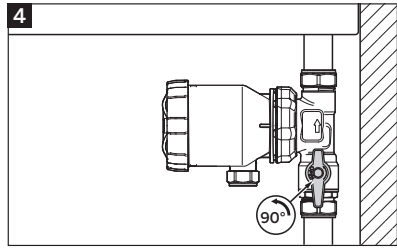
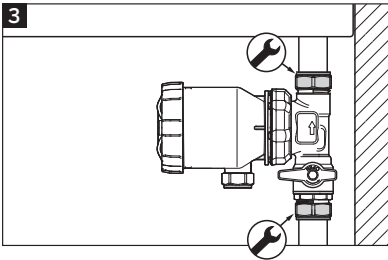
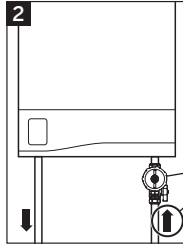
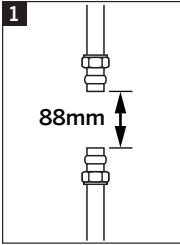
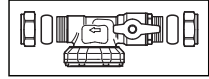

22mm

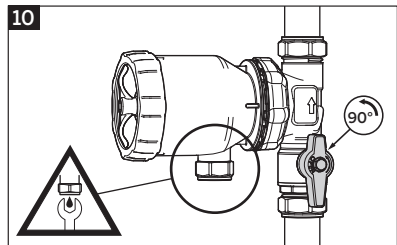
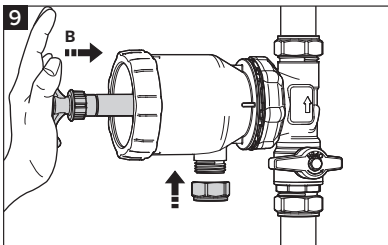
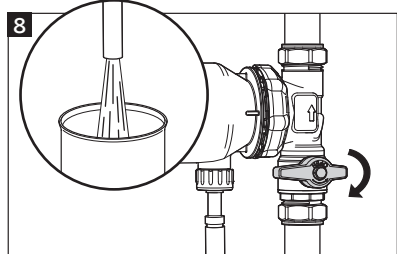
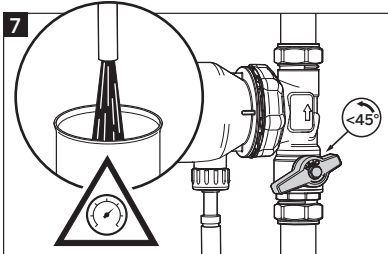
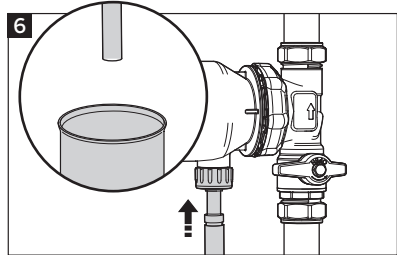
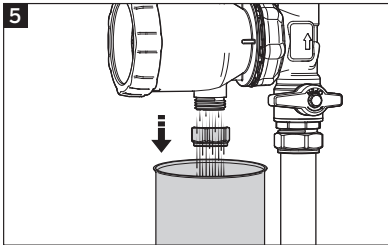
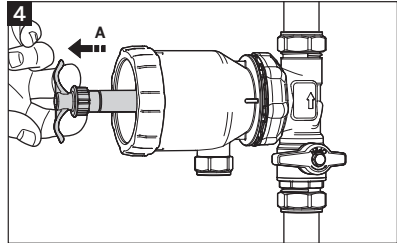
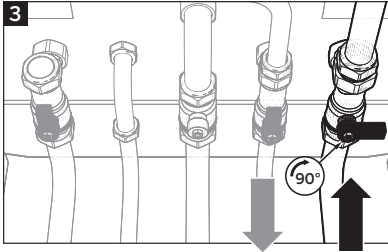
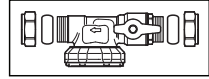

G3/4" M

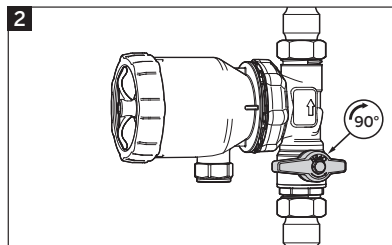
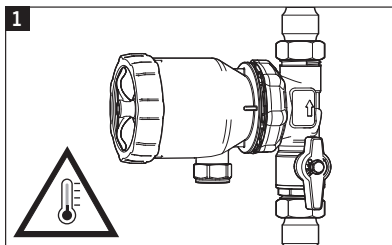
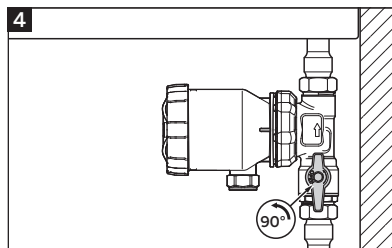
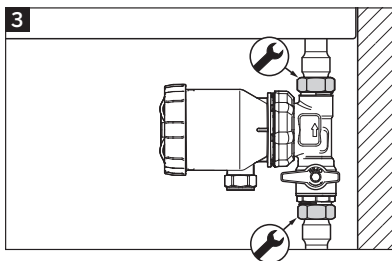
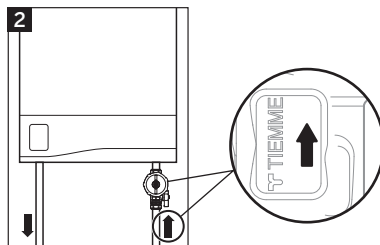
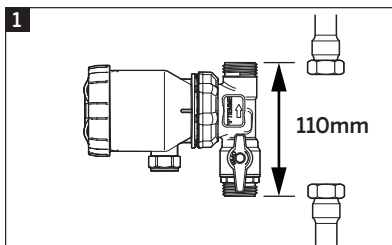
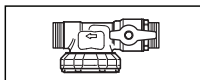

G3/4" M

